

User's
Manual

ERP PRO

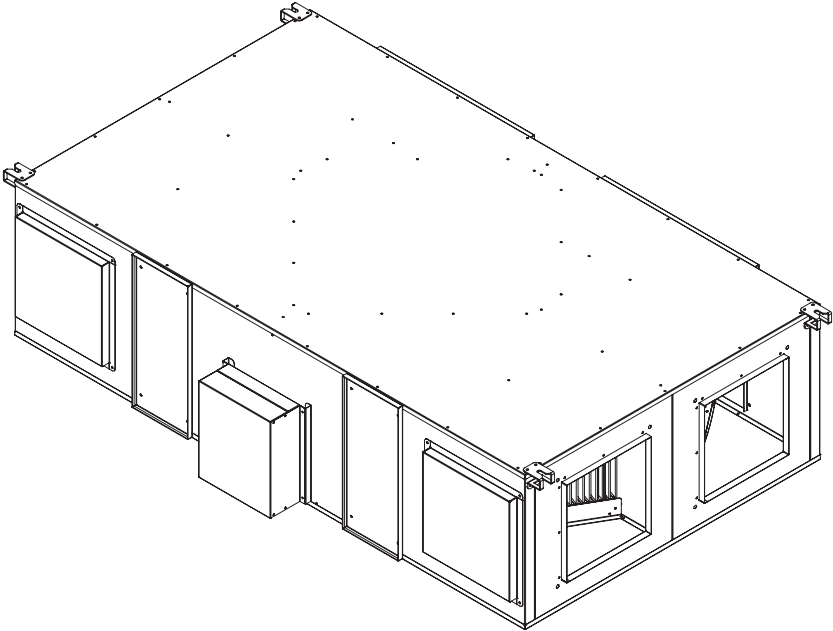



Cross Flow
Heat Recovery Unit

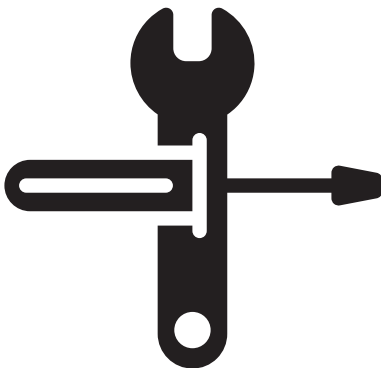

CONTENTS

Safety	3
Control List	4
ERP PRO	5
Technical Specifications	7
Dimensions	7
Performance Curves	8
EcoDesign Points	9
Components	9
Installation	10
Transportation & Storage	13
Electrical Connections	14
Wiring Diagrams	15
Controls	24
Maintenance	28
Troubleshooting	32
Warranty	34
Spare Part List	36
After Sales Service	37



	<ul style="list-style-type: none"> ■ This product must not be disassembled under any circumstances. Only authorized repair technicians are qualified to conduct disassembly and repairs. ■ Failure to heed this warning may result in fire, electrical shock or injury.
	<ul style="list-style-type: none"> ■ Do not install this product in a refrigerated warehouse, heated swimming pool or other location where temperature and humidity are significantly different. (Failure to heed this warning may result in electrical shock or malfunctioning.) ■ Do not install this product where it will be directly exposed to rain. (Failure to heed this warning may result in electrical shock or malfunctioning.) ■ Do not install this product in a location where acid, alkali or organic solvent vapors, paints or other toxic gases, gases containing corrosive components or high concentrations of oily smoke are present. (Failure to heed this warning may result not only in malfunctioning but also fire, power leakage and electrical shock.) ■ Do not use this product outside the range of its rated voltage and control capacity. ERP 1200, ERP 2200 and ERP 3200; Single phase, 220- 240 V, 50 Hz., ERP 4200 Three phase, 380- 400 V, 50 Hz. (Failure to heed this warning may result in fire or electrical shock.)
	<ul style="list-style-type: none"> ■ Install this product in an environment where the temperature ranges from -10 °C to +40 °C and the relative humidity is less than 80%. If condensation is expected to form, heat up the fresh outside air by a duct heater etc. ■ Select a position for introducing the outside air where no exhaust or combustion gases will be sucked into the fresh air duct and where it will not be covered by snow (Failure to ensure a supply of air can result in producing a state of Oxygen deficiency inside the room.) ■ Select an adequately sturdy position for installing the product and install it properly and securely. (Injury may result if the product should fall.) ■ Use the designated electrical wires for the terminal board connections and connect the wires securely so that they will not be disconnected. (Failure to ensure proper connections may result in fire.) ■ When passing metal ducts through wooden buildings clad with metal laths, wire laths or metal, these ducts must be installed in such a way that they will not make electrical contact with metal laths, wire laths or metal sheets. (Power leakage can cause ignition.) ■ The outside ducts must be tilted at a gradient(1/30 or more) downwards toward the outdoor area from the main unit, and properly insulated. (The entry of rain water may cause power leaks, fire or damage to household property.) ■ Gloves should be worn during installation. (Failure to heed this warning may result in injury.) ■ A dedicated circuit breaker must be installed at the origin of mains power supply. This circuit breaker must be provided with a means for locking (lock and key).
	<ul style="list-style-type: none"> ■ Connect the product properly to the ground. (Malfunctioning or power leaks can cause electrical shock.)
	<ul style="list-style-type: none"> ■ An isolator switch having a minimum contact gap of 3 mm in all poles must be provided as a means of disconnecting the power supply.

Control List

1 Make sure the unit receives power and grounding is done!

2 Make sure the length of electric cables is correct! (Check for overheating on cables!)

3 Check if the cables heading to the electrical box are shielded (protected against magnetic field) and shield is grounded. If not, replace!

4 Check if the exhaust and supply filters are clean and make sure they do not prevent air flow!

5 Make sure the drain hose is connected and check for any blockages through the drain line!
If needed, clean it!

6 Please check that the duct dimensions used in the duct system are correct and of the same dimension of the units duct connection. If wrong correct it with appropriate one.

7 Make sure there is enough service space for installation. If not, repeat installation.

8 In extremely cold climates in which freezing may occur on the heat recovery unit, use electric pre-heater at the fresh air suction to raise the air temperature to -8 °C or above.

9 Make sure electrical connections are done as it is described in this manual. Make necessary corrections if there is any faulty connection.

10 Check for unusual noise or vibration after the installation. If there is, control if anti-vibration pads are used.

The limited availability of energy resources has increased energy costs, making energy access difficult. States have begun to establish efficiency criteria in energy-using devices in order to reduce the consumption of limited energy, and these criteria have become compulsory for producers. The energy criteria in ventilation devices are determined by the European Union with the Ecodesign directive, which became compulsory since 2016 and it has been set as a prerequisite of CE certification.

Heat recovery ventilation appliances, which are present in a significant part of small, large and medium sized projects in the market, are listed in accordance with the heat recovery utilization and expenditure fan power criteria in the direction of the directive entered into force in 2016, and the entry of non-standard devices into EU countries is prohibited.

Special Features of ERP PRO

1. EC Fans with low SFP value.
2. Plate heat recovery exchanger with large heat transfer surface area ($\mu > 73\%$).
3. F7 on fresh air side, M6 class filter on exhaust air.
4. ECO-DESIGN 2018 compliant performance.
5. Easy Service thanks to service friendly casing design.
6. Modern Automatic Control.
7. By-pass Ventilation.

System Description

ERP units are designed for ventilation of spaces by means of exhausting stale air indoors and introducing fresh air from outdoors. ERP units recover part of the energy of the exhaust stream to precondition fresh air. The energy recovered is transferred to the fresh air and reduce the necessary load of the air conditioning system.

Heat Exchange Mode

Return Air from the indoors passes through the heat recovery exchanger and is ejected outdoors. Fresh outdoor air is supplied through the heat exchanger.

ERP PRO

Bypass Ventilation Mode

The main function of Automatic bypass is not to channel the fresh outside air through the heat exchanger, but rather through the “bypass channel” in the unit past the heat exchanger and directly into the supply air rooms.

Bypass closed:

- Outside air is channeled through heat exchanger into the room = Active heat recovery

Bypass opened:

- Outside air is channeled through heat exchanger into the room = Active heat recovery.
- Outside air is channeled directly into the room = Inactive heat recovery, indirect “cooling “of room air.

The bypass is normally used in the summer months for “night cooling “. With regard to night cooling, the effect of cool outside temperatures is used in comparison to room or inside temperatures.

The bypass can also be used in transition periods (spring and autumn) if the room temperature is significantly higher than the outside air temperature during the day due to high windows (“natural bypass cooling “).

The night cooling effect and “natural bypass cooling “is strongly influenced by the temperature differences between outside air/supply air and room air, the flow rate, the shade and the required cooling loads. Bypass cooling will never replace air conditioning

Technical Specifications

Model	ERP PRO			
	1200	2200	3200	4200
MAXIMUM AIR FLOW (m ³ /h)	1170	2000	3200	4200
MAXIMUM POWER CONSUMPTION (W)	1000	960	1560	3000
MAXIMUM CURRENT (A)	5,00	5,00	7,80	4,80
SUPPLY VOLTAGE	230 V / 50 Hz / 1 ~			380 V / 50 Hz / 3 ~
FILTER CLASS (EXHAUST/FRESH AIR)	M6/ F7			
WEIGHT (kg)	148	195	406	420
SOUND PRESSURE (dB)	49	49	53	48

Sound values are measured for a ducted unit at 250Hz and 1,5m away from the unit.
The filter class is specified according to EN779: 2012 standard.

Dimensions

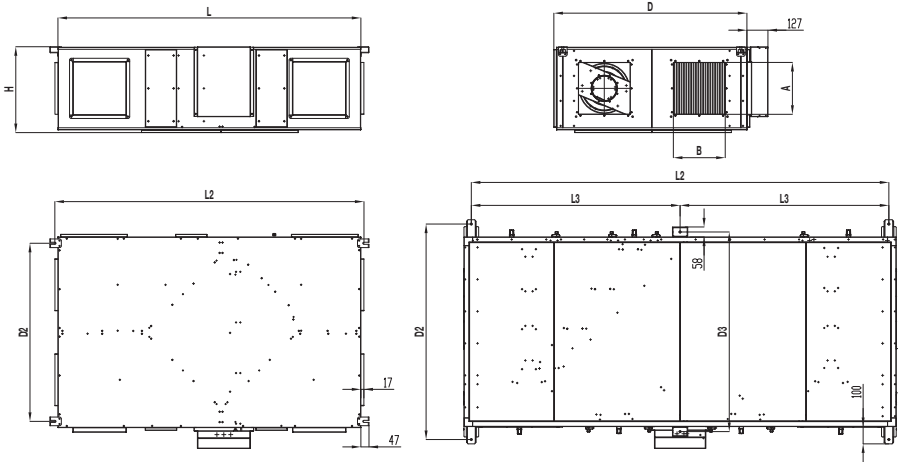

MODEL	DIMENSIONS							
	L	D	H	L2	D2	L3	D3	AXB
	mm							
ERP PRO 1200	1752	1102	500	1790	1030	-	-	300x300
ERP PRO 2200	1990	1232	580	2030	1150	-	-	350x350
ERP PRO 3200	2500	1600	685	2415	1750	1207.5	1658	435x435
ERP PRO 4200	2500	1600	815	2415	1750	1207.5	1658	435x435

Performance Curves

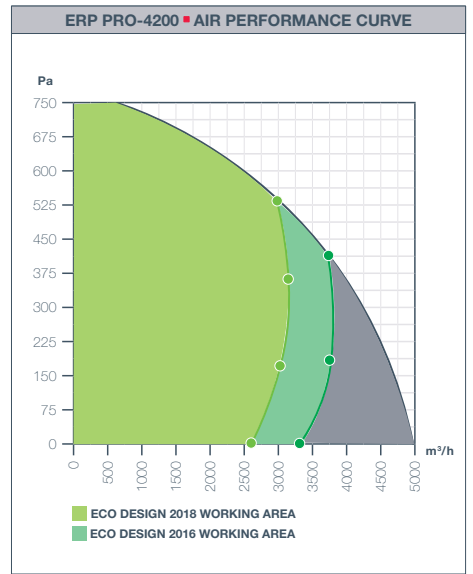
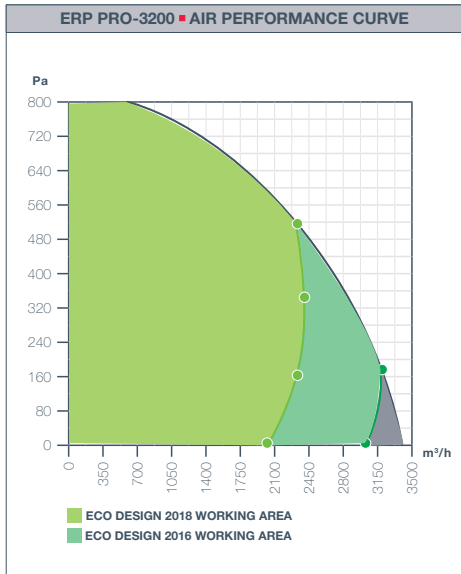
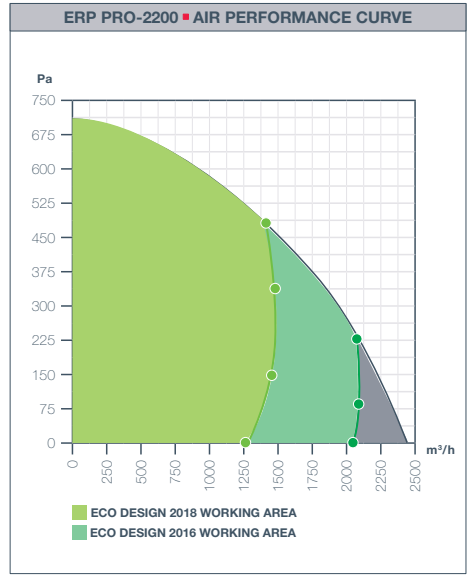
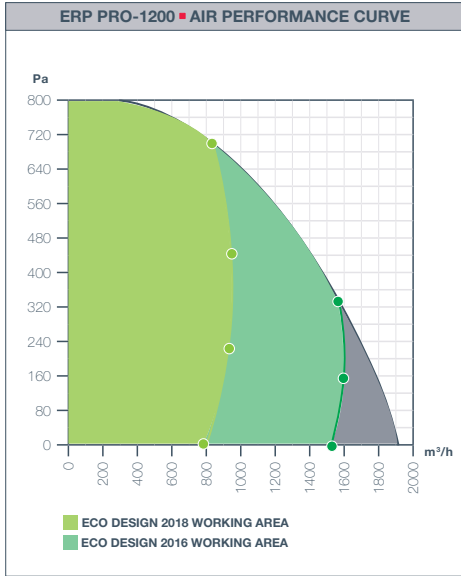

EcoDesign Points

EcoDesign Points				
	ERP PRO 1200	ERP PRO 2200	ERP PRO 3200	ERP PRO 4200
Declared typology	Bidirectional	Bidirectional	Bidirectional	Bidirectional
Type of drive	Variable	Variable	Variable	Variable
Type of HRS	Recuperative	Recuperative	Recuperative	Recuperative
Thermal efficiency of heat recovery [%]	73	73	73	73
Nominal NRVU flow rate [m ³ /h]	1170	2000	3200	4200
Effective electric power input [kW]	0,4	0,95	1,45	2,76
SFPint [W/(m ³ /s)]	574	538	685	767
Face velocity [m/s]	1,42	1,68	1,85	1,94
Normal external pressure [Pa]	100	100	100	100
Internal pressure drop of ventilation components [Pa]	243	283	366	390
Static efficiency of fans [%]	54,7	59,9	59,4	54
Declared maximum external leakage [%]	<1	<1	<1	<1
Declared maximum internal leakage [%]	<3	<3	<3	<3
Description of visual filter warning	Time controlled			
Casing sound power level (Lwa) [dB(A)]	58	57	61	63
ErP Compliance	2018	2018	2018	2018

Components

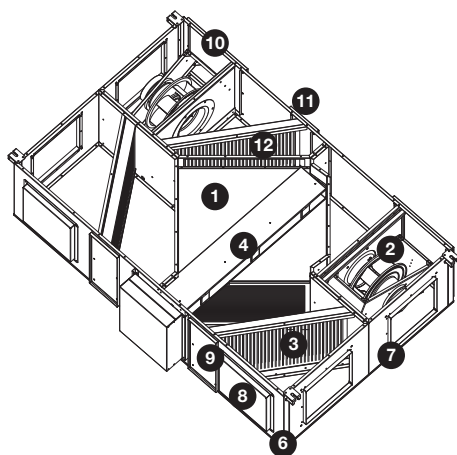

- 1 Heat Exchanger
- 2 Fan
- 3 Filter
- 4 By-Pass Damper
- 5 Controls
- 6 Casing
- 7 Duct Connections
- 8 Alternative Duct Connections
- 9 Filter Service Cover
- 10 Fan Service Cover
- 11 Second Stage Filter Service Cover
- 12 Optional Second Stage Filter

Installation

Mounting the Appliance

VESTA ERP series appliances can directly be mounted on a vibration-free solid wall with the suspension parts supplied for installation purpose. The screws must be applied in a torque enough to secure a rigid connection. The other part is mounted to the wall and used as a hanger to fix the unit. Following aspects must be considered during mounting of the unit.

- The device must be installed at the ceiling level.
- The installation space must be freezing free.

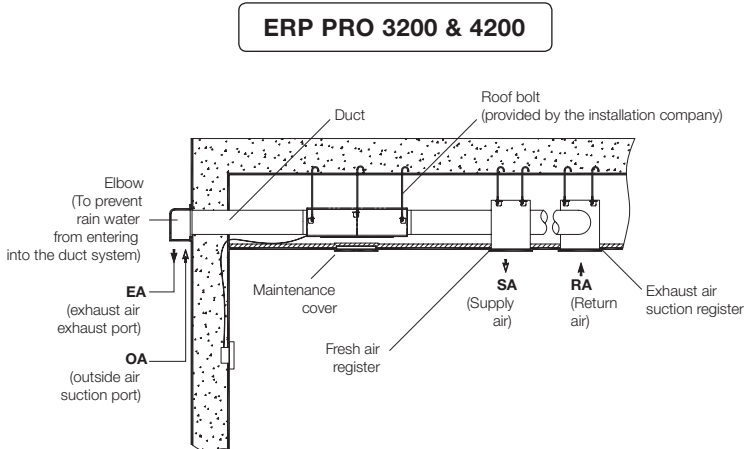
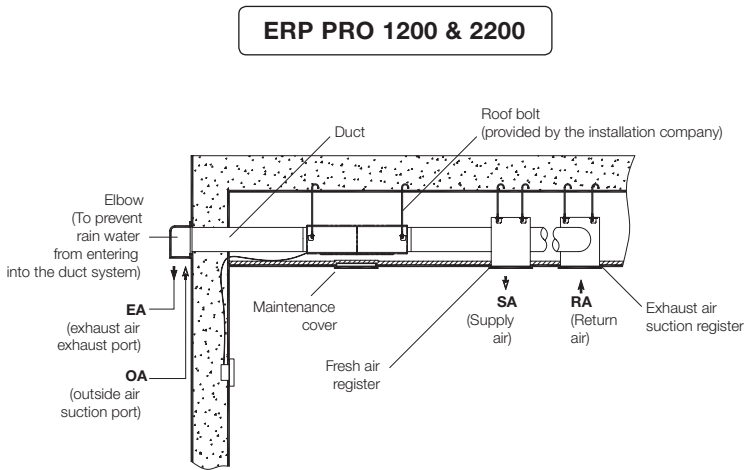

Installation

The distribution ducts should be connected to the unit through rigid or semi flexible ducts in order to avoid abnormal sounds and vibration. Flexible ducts may also be used ensuring that the structure of the duct does not block the air stream and cause vibration.

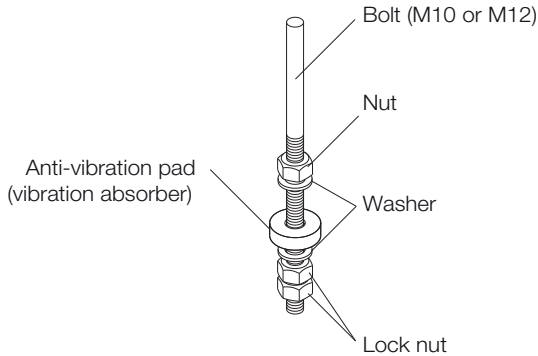

WARNING  **Check the strength of the stems during assembly.**

Installation

Connecting the ducts

The duct connections in the unit are made of ABS material hence do not need additional insulation. After connecting the unit; make sure that there is no leakage between the duct connections of the unit and the duct. Use a duct tape where necessary.

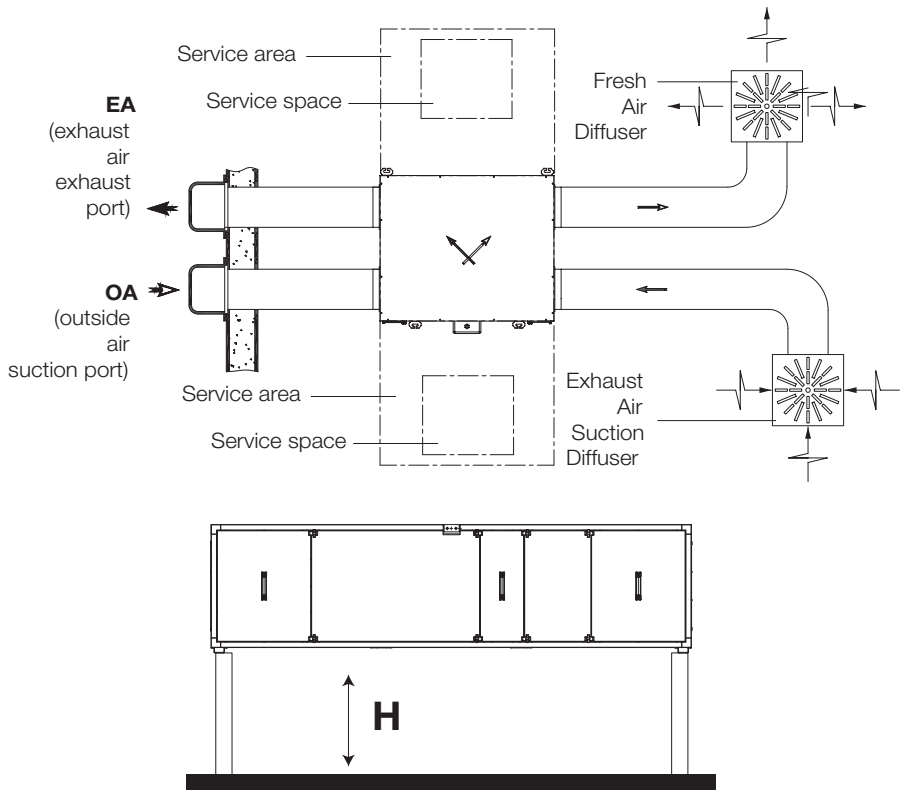

Model	SIDE SERVICE AREA DXL	HEIGHT FROM THE BOTTOM SERVICE H
ERP PRO 1200	750mm x1850mm	600mm
ERP PRO 2200	850mm x2100mm	750mm
ERP PRO 3200	1000mm x2500mm	750mm
ERP PRO 4200	1000mm x2500mm	900mm

Installation

- Before connecting the ducts, check that no sawdust or any other foreign material (scraps of paper, vinyl, building material etc.) exist in the ducts.
- Do not touch the damper clamp (plate) inside the unit when connecting to ducts as it may cause malfunctioning of the by-pass system.
- Do not install the ducts as shown on the following figures. Doing so will increase the pressure drop, decrease the air volume from the unit and give rise to abnormal sounds.

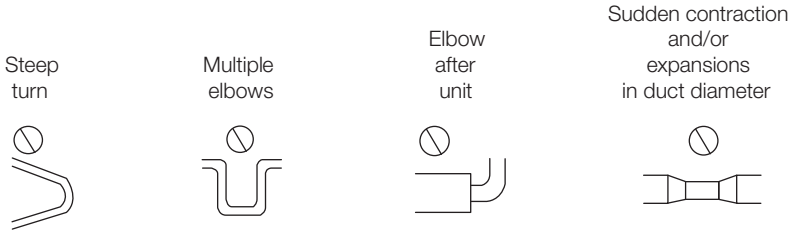

Transportation & Storage

Transportation

All heat recovery devices manufactured by AERA are passed through all tests and controls and shipped from the factory. Appropriate lifting methods should be used to prevent damage to the heat recovery devices during vertical or horizontal transportation. Transpallets or forklifts can be used to carry and lift these devices. During lifting and transportation, the appliance must be secured and safety measures must be taken for safety. Lifting and carrying should be done by trained and experienced personnel. Ensure that the weight is uniformly distributed across the four corners during carry of the devices.



Storage

All heat recovery devices manufactured by AERA are located in a place after shipment. If storage is required, close all openings to avoid contamination. The environment in which the heat recovery device is stored should have a minimum temperature of -20°C , a maximum temperature of $+40^{\circ}\text{C}$ and a maximum of 80% relative humidity. It must be stored in a closed box away from dust and moisture to avoid damaging the devices. Prevent the electrical components and components from being damaged when performing the packaging of the device. Accessories such as filters, must be packaged separately to avoid exposure to dust and moisture.

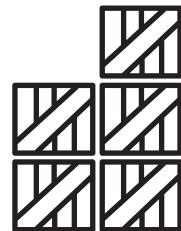

Electrical Connections

The figure shows the terminal of ERP PRO units. Both the remote control and the mains must be connected to the terminal shown. L, N connections must be connected to the main electrical distribution system and A, B must be connected to the remote controller. In the remote control there exists a mini PCB terminal named with the same letters. In the electrical box the ground must also be connected from the main electrical distribution system.

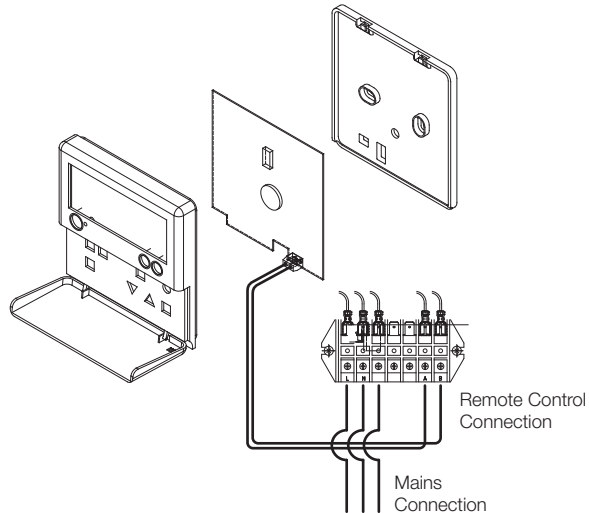

- Ensure that the field supplied electrical components (mains power switch, circuit breakers, wires, connectors and wire terminals) have been properly selected according to the given data. Make sure that they comply with national and regional electrical codes. Make sure that the cable section used among connections are not smaller than 1,00 mm² for standard units and 1,5 mm² when electrical pre heater is used as listed in EN 60335-1 European Standard
- Please make sure that for Remote Control connection a shielded cable is used and connected to the ground properly.
 - In the case that power cabled are connected in series, add each units / components maximum current and select wires according to below table.
 - Follow local codes and regulations when selected field wires, circuit breakers and earth leakage breakers.
 - Use the wires which are not lighter than the ordinary polychloroprene sheathed flexible cord.

Wiring Diagram

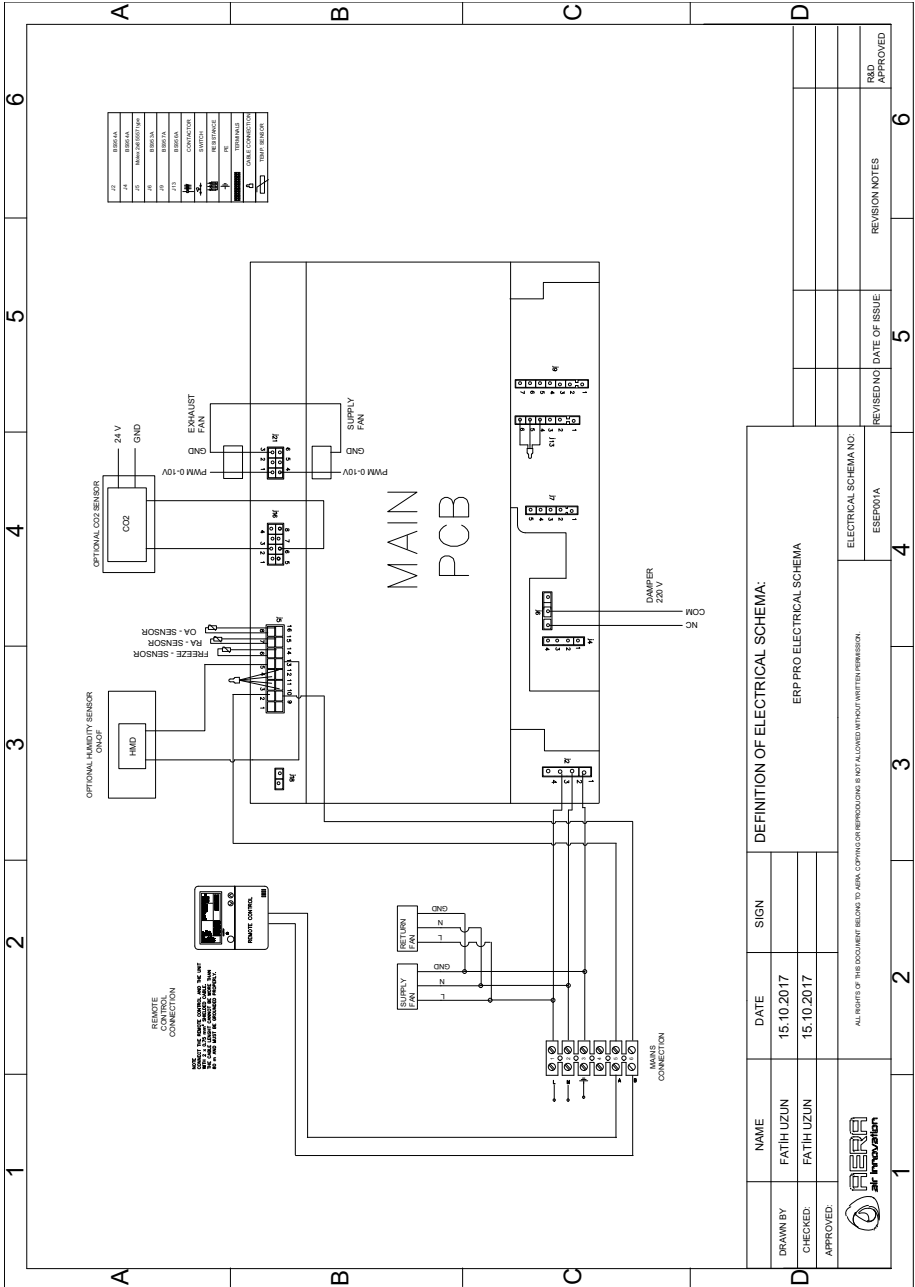

Wiring Diagram

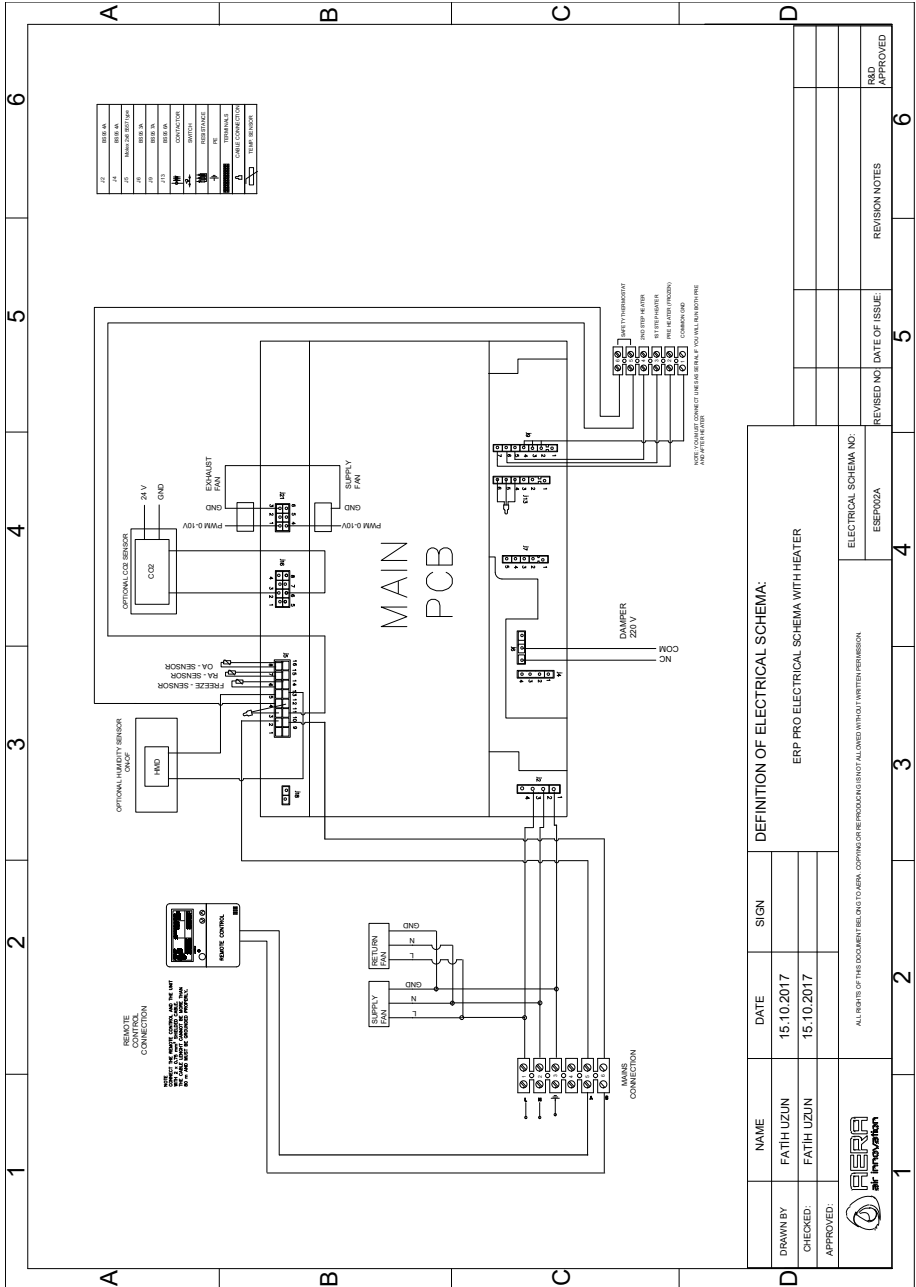

Wiring Diagram

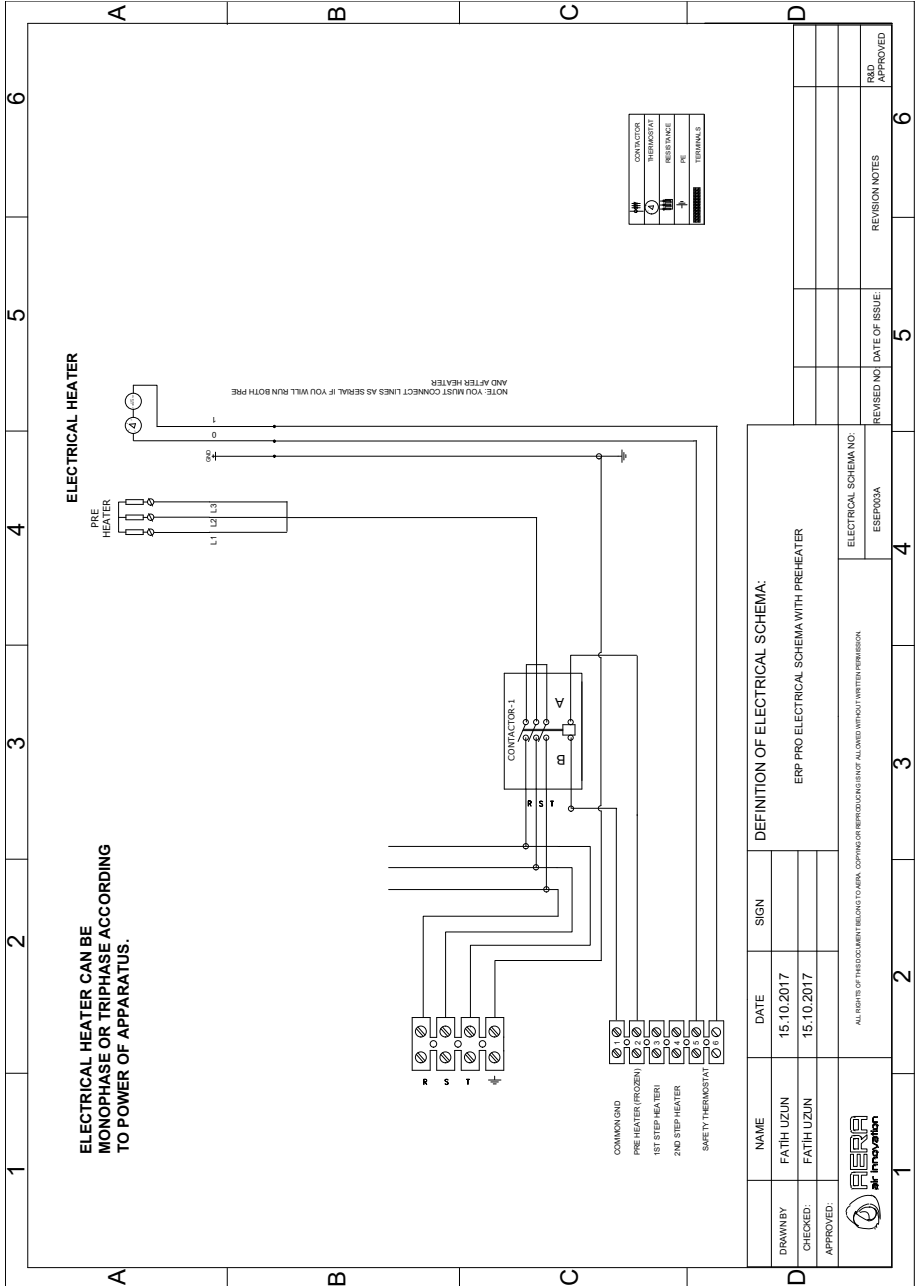

Wiring Diagram

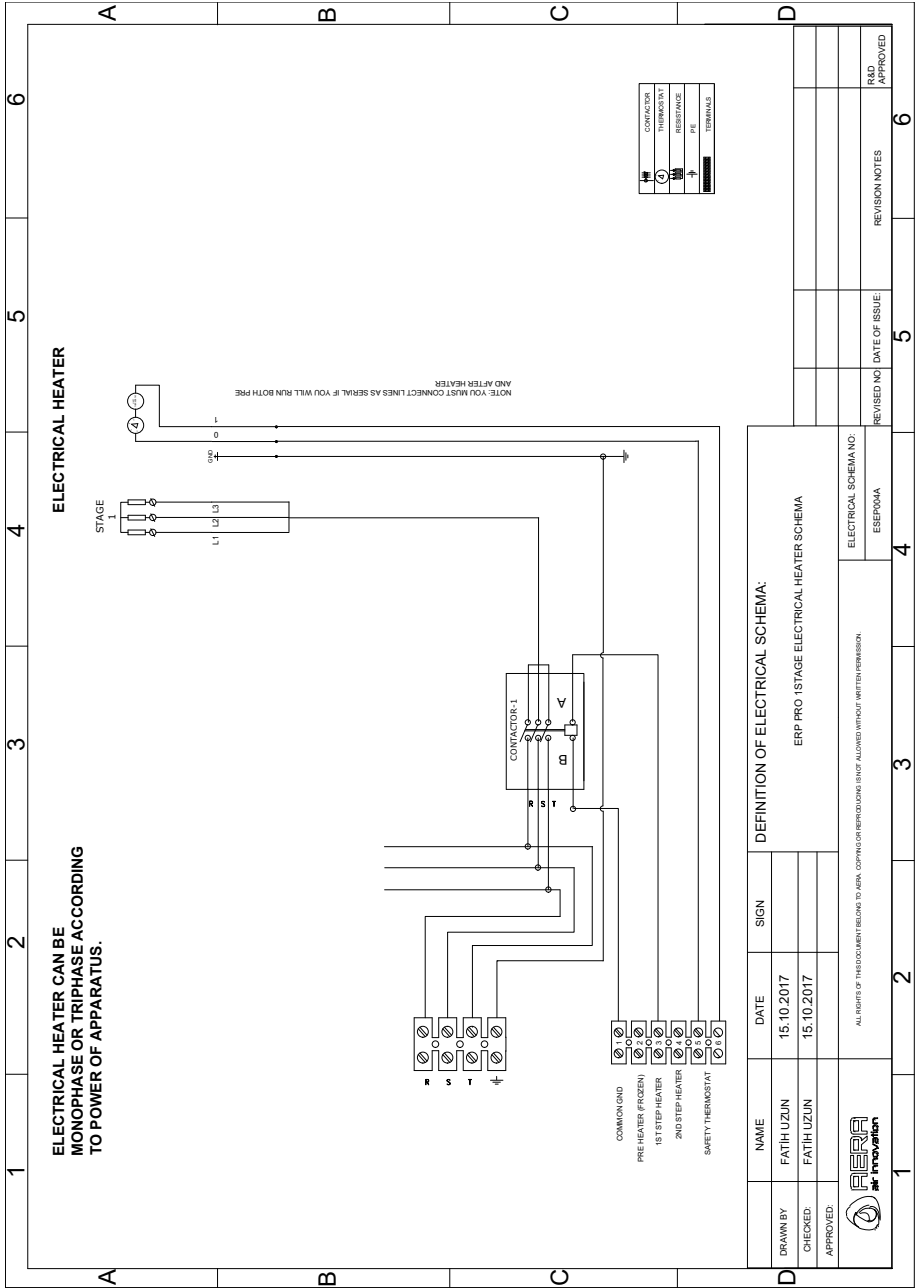

DEFINITION OF ELECTRICAL SCHEMA:	
NAME	ERP PRO 1STAGE ELECTRICAL HEATER SCHEMA
DRAWN BY	FATH UZZUN
CHECKED:	FATH UZZUN
APPROVED:	
ELECTRICAL SCHEMA NO: ESEPR004A	
REVISION NO	DATE OF ISSUE
REVISION NOTES	
ADD	APPROVED



ALL RIGHTS OF THIS DOCUMENT BELONG TO AERA. COPYING OR REPRODUCING IS NOT ALLOWED WITHOUT WRITTEN PERMISSION.

Wiring Diagram

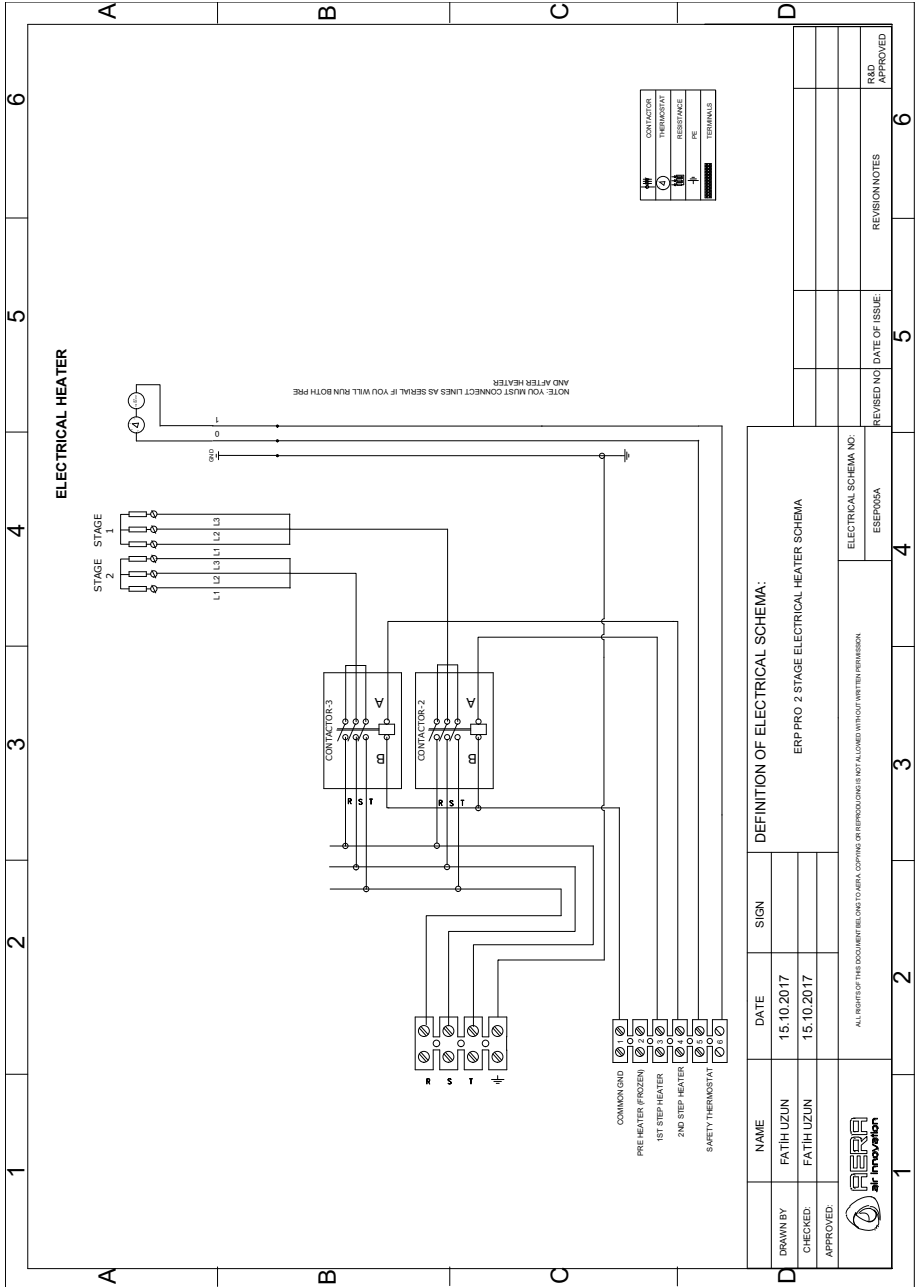

Wiring Diagram

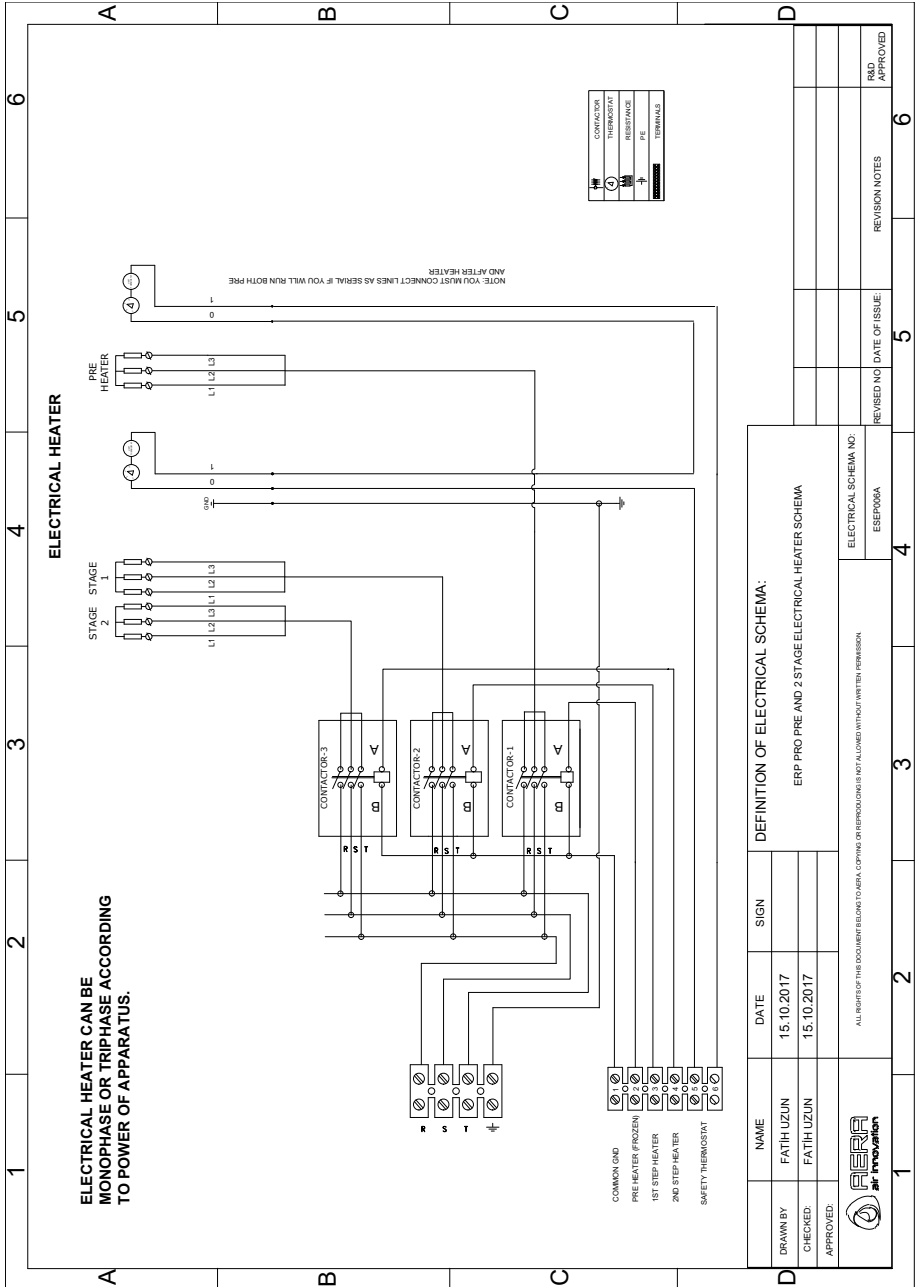

DATE	SIGN	DEFINITION OF ELECTRICAL SCHEMA:	REVISION NO	DATE OF ISSUE	REVISION NOTES	REV. APPROVED
15.10.2017	FATH-UZZUN	ERP PRO PRE AND 2 STAGE ELECTRICAL HEATER SCHEMA				
15.10.2017	FATH-UZZUN					
		ELECTRICAL SCHEMA NO: ESE006A				

Wiring Diagram

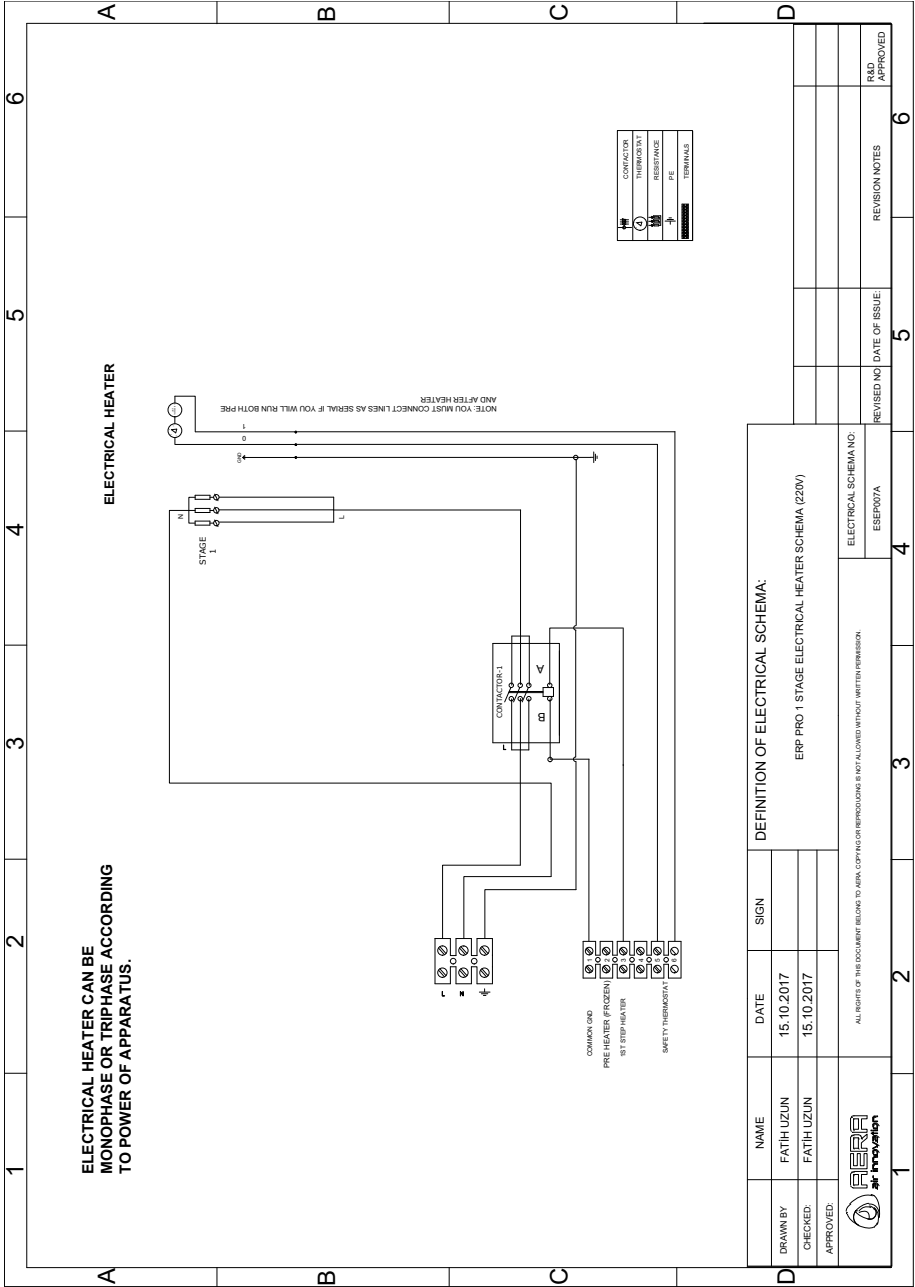

Wiring Diagram

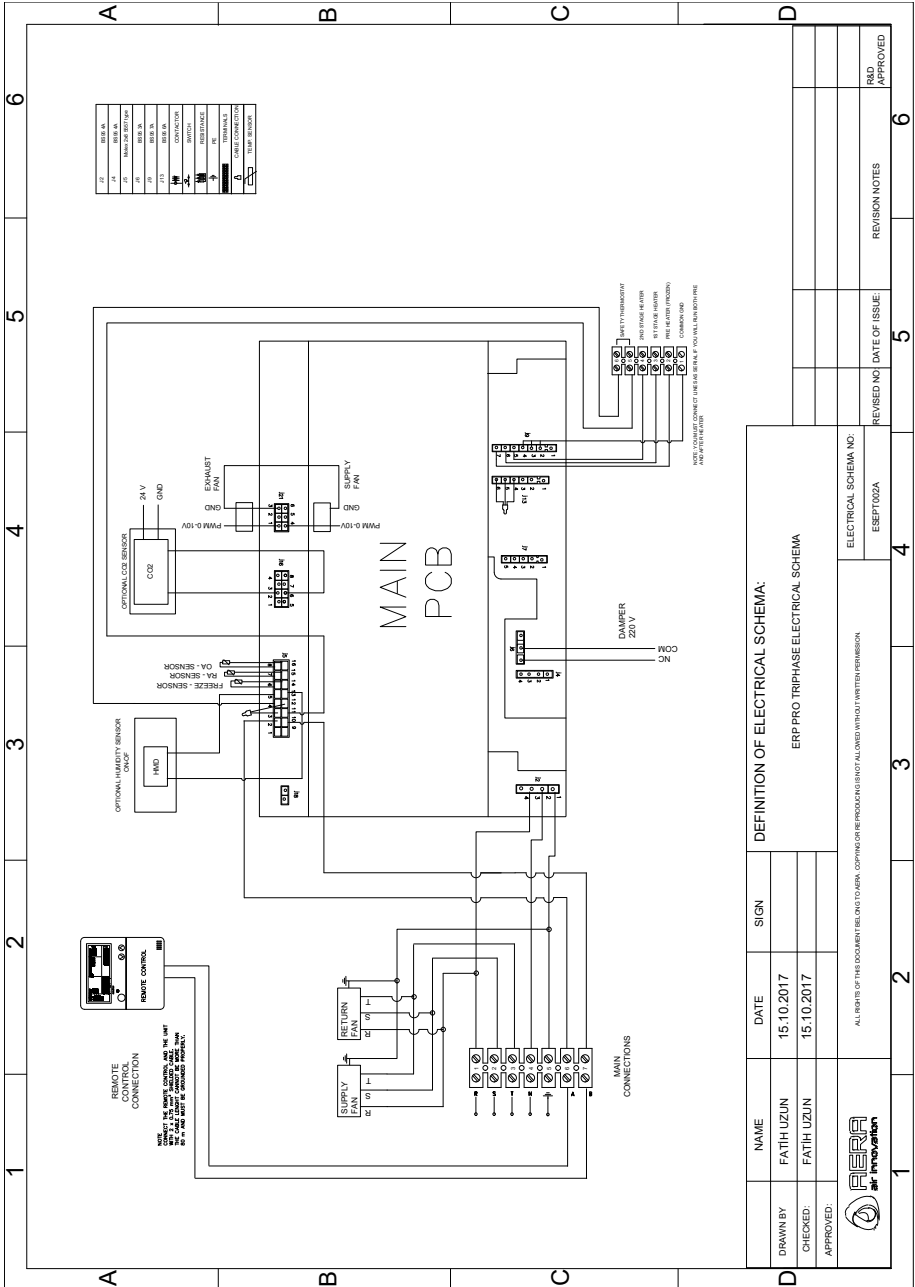

Controls

► Button Functions

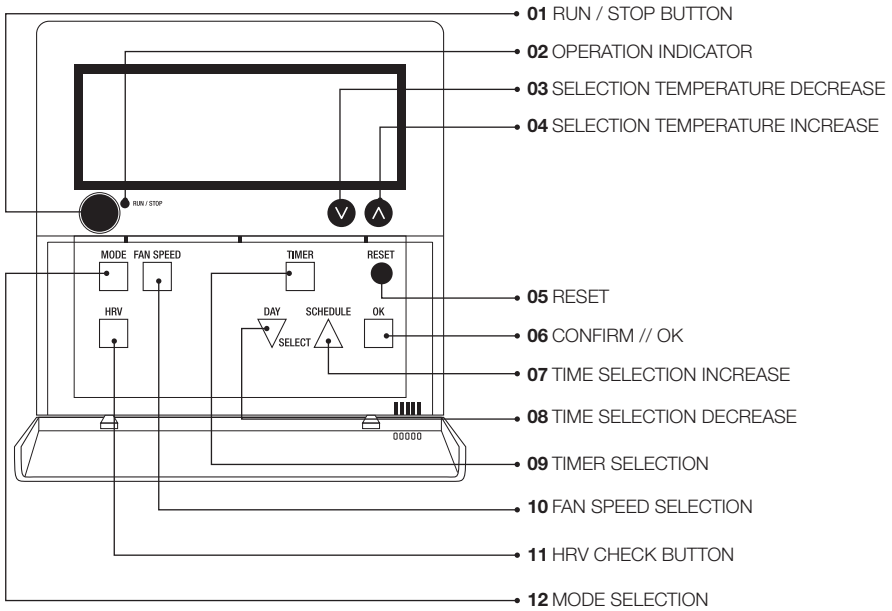

► LCD Functions

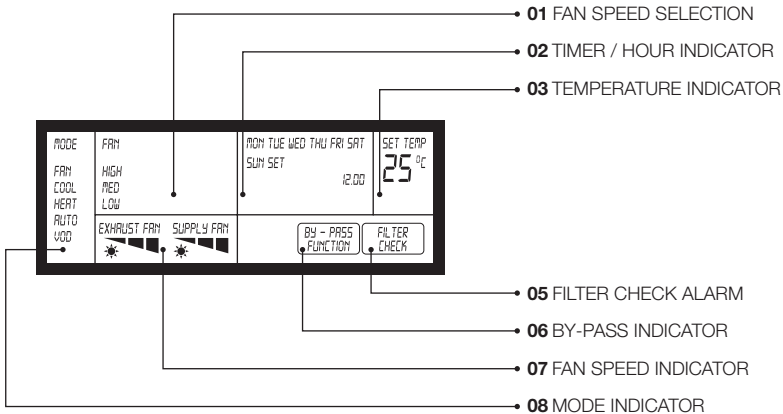

Remote Control Functions

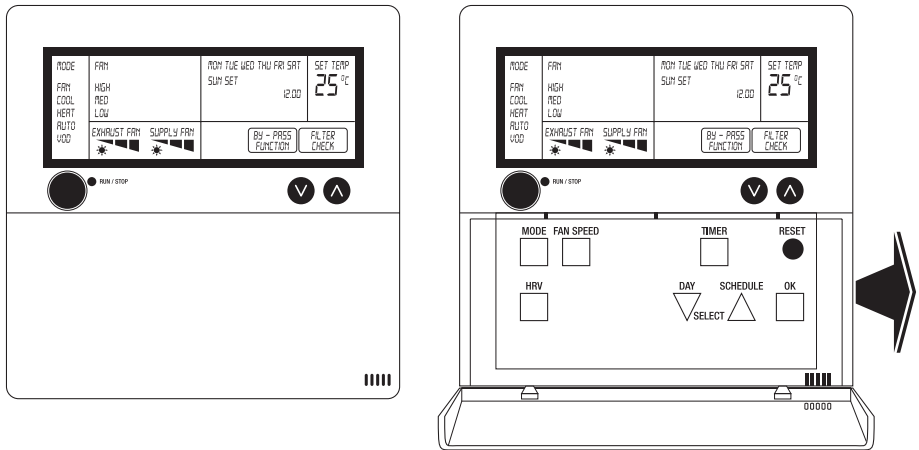

RUN / STOP

When the backlight and led is off, press the button once to turn the unit on. When the unit is “on” press on/off 2 seconds to switch it off



Increase/decrease set point room temperature (SET TEMP is on)

MODE

Press to select the listed modes of operation (FAN, COOL, HEAT, AUTO, VOD). Every time a button is pressed a next mode lights up. After a 5 seconds delay the mode will be activated. The text MODE on display is always visible.

FAN

With this button the fan speed of the

- Pressing once: text FAN lights up. “EXHAUST FAN” and current fan speed (text) starts blinking
- Use buttons to select fan speed (high, med, low)
- Press OK to confirm
- “SUPPLY FAN” and current fan speed (text) starts blinking
- Use buttons to select fan speed (high, med, low)
- Press OK to confirm
- Text FAN and HIGH, MED, LOW lights up

TIMER

Press to set timer function on/off. When “on” the display shows SET

RESET

Press to reset filter check. When “on” the display shows FILTER CHECK. Default Filter Check the value in use in parameter list 2.3.3.

Controls

LCD Functions





CHANGE TIME

- Press OK button for 3 seconds, time starts blinking.
- Change time with ▲ ▼ buttons. Time starts to change faster are pressed for a while.
- Press OK to confirm, current day starts blinking.
- Change day with ▲ ▼ buttons.
- Press OK to confirm

Press RUN / STOP to stop immediately and go back to normal operation

TIMER FUNCTION

The timer function can be used to program block times in which the unit is operating. Outside the blocks the unit is off. The timer function makes it possible to program 2 on/off times per day.

- Press TIMER button for 3 seconds, day MON starts blinking, all other LCD segments are off
- Press DAY button (one or more times) to select the day to be set
- Press OK to confirm, the selected day is permanent on
- The temp display shows  which means timer block 1 “on” time can be programmed
- Adjust the “on” time with the DAY and SCHEDULE buttons, press OK to confirm
- Next the timer block 1 “off” time can be programmed, the temp display shows 
- Again adjust the “off” time with the DAY and SCHEDULE buttons, press OK to confirm
- Next the timer block 2 “on” time can be programmed, the temp display shows 
- Adjust the “on” time with the DAY and SCHEDULE buttons, press OK to confirm
- The temp display shows  which means timer block 2 “off” time can be programmed
- Again adjust the “off” time with the DAY and SCHEDULE buttons, press OK to confirm
- Now the next day starts blinking and can be programmed accordingly as described above.
- To exit the programming mode press OK for 3 second or wait 1 minute

ADDITIONAL FEATURES

- A specific “on” or “off” time can be deleted by pressing RESET when programming the time block. If deleted the time display shows:  and the time is not used.
- When for example the unit is “on” on Monday and no “off” time is programmed that day anymore, the unit remains “on” until the first “off” time is reached the next day(s). The same sequence is used when the unit would be “off”

Example 1 – Normal Blocks

MON

Time display

Temp Display



1st “on” time - unit starts on Monday at 8:00



1st “off” time - unit starts on Monday at 12:00



2nd “on” time - unit starts on Monday at 14:00



2nd “off” time - unit stops on Monday at 18:00

Example 2 – Overlapping Blocks

MON

Time display

Temp Display



1. 1st “on” time - unit starts on Monday at 8:00



1. 1st “off” time - unit stops on Monday at 12:00



2nd “on” time – No action

Time programmed before 1st stop time, unit remains off



2nd “off” time - unit stops on Monday at 18:00

Time programmed before 1st stop time, unit remains off

Example 2 – Overlapping Blocks

MON

Time display

Temp Display



1. 1st “on” time - unit starts on Monday at 8:00



1. 1st “off” time - unit stops on Monday at 12:00



2nd “on” time – No action



2nd “off” time - unit stops on Monday at 18:00

Maintenance

- Turn off all power switches before maintenance.
- Do not turn on the unit without the air filter mounted otherwise blockages may occur.
- Check the filters every six months and, if necessary, changed
- Clean the heat recovery exchanger at least once in every two years

Cleaning of The Heat Recovery Exchanger



Heat Recovery Exchanger Weights	
ERP PRO 1200	29 kg
ERP PRO 2200	51 kg
ERP PRO 3200	86 kg
ERP PRO 4200	103 kg

ERP 1200 & ERP 2200

1) loosen screws to remove service doors

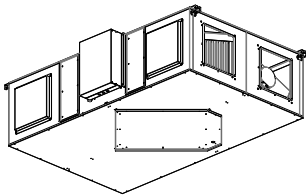

2) carefully pull out the heat recovery exchanger with service door after loosening the screws

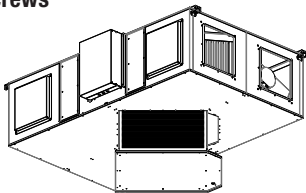

ERP 3200 & ERP 4200

1) loosen screws to remove service doors

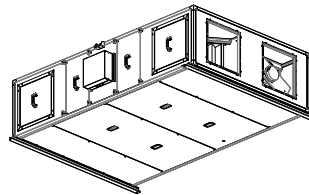

2) carefully leave the service door at a convenient place

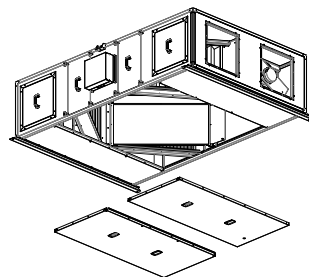

ERP 1200 & ERP 2200

3) Clean the heat recovery exchanger with hot water or steam. Use natural detergent or soap powder if need be. Leave it to dry after cleaning and mount it to the unit after it is completely dry. Tighten the service cover screws thoroughly and make sure the heat recovery exchanger does not fall down.

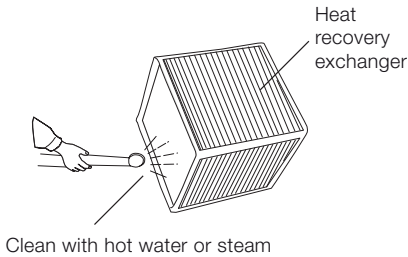

ERP 3200 & ERP 4200

3) carefully pull out the heat recovery exchanger after loosening the screws

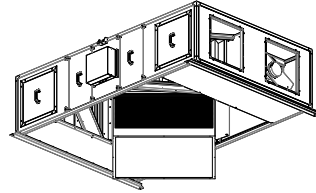

4.a) Clean the heat recovery exchanger with hot water or steam. Use natural detergent or soap powder if need be. Leave it to dry after cleaning and mount it to the unit after it is completely dry. Tighten the service cover screws thoroughly and make sure the heat recovery exchanger does not fall down.

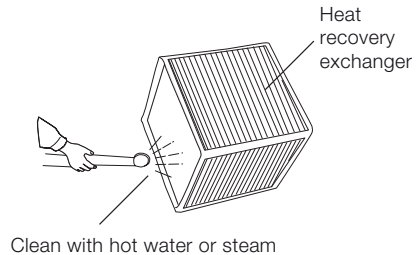

4.b) if the heat recovery exchanger is too heavy, you can use a vacuum cleaner to absorb dust and dirt on the exposed surfaces of the heat exchange elements without removing the heat exchanger from its place. Attach a nozzle with a brush to the vacuum cleaner for this job and clean the elements by passing the brush lightly over their exposed surfaces.

Maintenance

Filter Maintenance

Make sure that the power connection is disconnected before doing any work on the device. Danger of electric shock; moving parts (fan) and hot surfaces.

The inspection openings on the ventilation unit enable the easy change of external filter (F7) and exhaust air filter (M6)

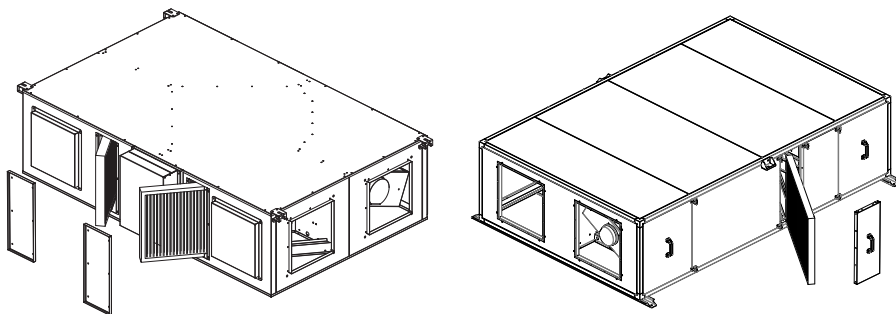

- I. Filter service doors are on the side of the device
- II. Unscrew the screws of the device service doors
- III. Remove the service door completely
- IV. Remove filter from slides
- V. Be careful to air flow direction when installing the filter back

It is recommended that filters be checked every six months for degree of soiling (danger of mould formation) and, if necessary, changed.

Even if the filters have not reached the level of pollution, they are recommended to be replaced within 1 year. If the filters are damp or mouldy, they must be exchanged immediately!

Service and Maintenance of Fans

Make sure that the power connection is disconnected, and fan is not moving before doing any work on the device.

- I. Unscrew the screws of the device service doors. Open device service covers.
- II. Unplug the power connector on the fan
- III. Remove the fan pressure hoses (if there is a connection with fan)
- IV. Remove the fan slowly and carefully
- V. Be careful to electrical connections when installing the fans back into

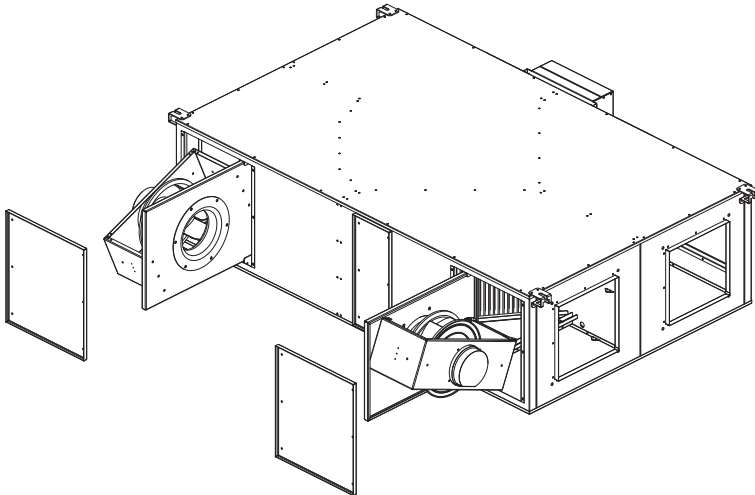

Troubleshooting

Fault	Reason	Solution
Fans Do Not Work	a. Power supply off	a. Turn on the power supply
	b. No signal from the control panel	b. Press the correct buttons of the control panel
	c. Incorrect or loose electrical connection	c. Connect connections correctly
	d. Motors in thermal protection mode	d. Check motor current
Low Air Flow	a. Filters clogged or dirty	a. Change filters
	b. Air duct is clogged	b. Check the air ducts
High Air Flow	a. Channel connections are incomplete.	a. Check the duct system for leaks and complete the connections
	b. Grilles are not mounted	b. Mount the grilles
	c. Filters are not mounted	c. Mount the filters
Drainage Water Can Not Be Discharged	a. Incorrect installation of drainage pipe.	a. Mount the drain pipe correctly

Troubleshooting

Alarms

In the figure you can see what errors are displayed on the remote control. When there is an error the remote control display, switch off the unit and inform your local contact.

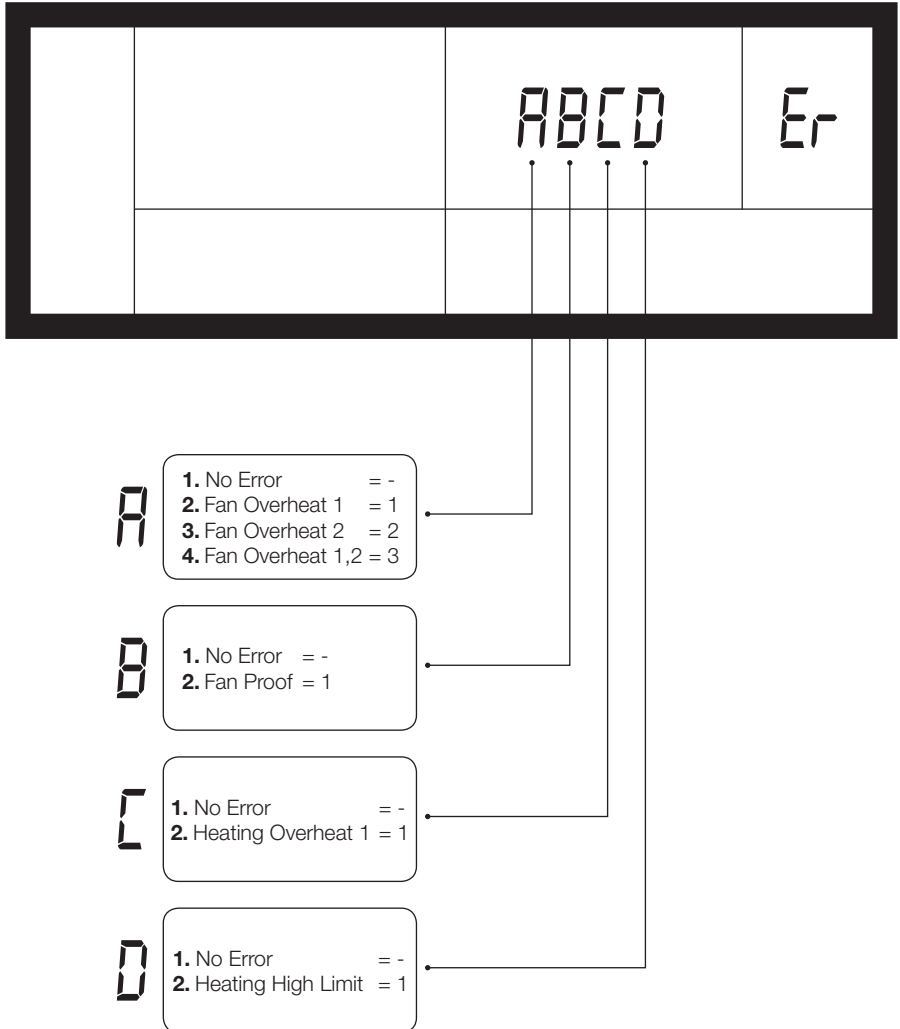

Warranty

This device is designed to operate efficiently and safely in the event that they are installed in accordance with the instructions in the operating instructions, and the operating and maintenance requirements are fully met. All maintenance procedures required for the device must be carried out by experts and authorized persons.

Warranty Conditions

- The devices are warranted against defects in material and workmanship for two (2) years.
- During the warranty period of the device, due to material and manufacturing mistakes in the event of a malfunction, the following conditions will not be charged;
 - a. Labor costs
 - b. Change value of the parts
- The user should report within 8 days of production defects or defects, in terms of the validity of the warranty, immediately upon the detection of defects, device will be stopped
- As explained in the instruction for use and maintenance, the warranty is valid as long as the devices are periodically maintained.
- Consumables that are periodically changed during the warranty period must be originally supplied from AERA.
- Warranty does not apply to consumables, eg filters.

Issues to be Considered by Customers Related to Warranty

The AERA service personnel or the services authorized by AERA should intervene for the devices covered by the warranty. Damage caused by installation mistakes or by unauthorized persons is not covered by the warranty.

The following conditions are not covered by warranty:

- Damage due to transportation and improper placement
- Damage caused by operating the device outside the operating conditions
- Damage caused by the use of spare parts not approved by the manufacturer
- Damage due to improper electrical connections, connection other than that specified on the electrical diagram label

Warranty

- Damage and failures due to factors such as impact, breaking, scratching and freezing.
- Faults that may arise from irregularities in the electrical supply where the device is installed
- Damage caused by failure to make drainage pipe and to be corrosion inside the device
- Damage that may be caused by the corrosive and acidic effect of the environment in which the device will operate
- Damages caused by foreign materials forgotten in the device or fan motor
- Damage caused by not using flexible connection in channel connections
- Damages caused by failure to observe the points specified in this user manual

Spare Part List

Description	Unit Model	Order Code
Fan Assembly	ERP PRO 1200	
Fan Assembly	ERP PRO 2200	
Fan Assembly	ERP PRO 3200	
Fan Assembly	ERP PRO 4200	
Heat Exchanger Assembly	ERP PRO 1200	
Heat Exchanger Assembly	ERP PRO 2200	
Heat Exchanger Assembly	ERP PRO 3200	
Heat Exchanger Assembly	ERP PRO 4200	
M6 Filter	ERP PRO 1200	
M6 Filter	ERP PRO 2200	
M6 Filter	ERP PRO 3200	
M6 Filter	ERP PRO 4200	
F7 Filter	ERP PRO 1200	
F7 Filter	ERP PRO 2200	
F7 Filter	ERP PRO 3200	
F7 Filter	ERP PRO 4200	
F8 Filter	ERP PRO 1200	
F8 Filter	ERP PRO 2200	
F8 Filter	ERP PRO 3200	
F8 Filter	ERP PRO 4200	
F9 Filter	ERP PRO 1200	
F9 Filter	ERP PRO 2200	
F9 Filter	ERP PRO 3200	
F9 Filter	ERP PRO 4200	
Control Panel	ERP PRO 1200/2200/3200/4200	

After Sales Service

AERA heat recovery devices do not have any parts replacement or repair work to be performed by the user other than cleaning and eye inspection. Users should contact the AERA company for faults detected during operation or maintenance. If you have problems and need to get a service, please contact the following address.



Distributed by **frigicoll**

MAIN OFFICE
Blasco de Garay, 4-6
08960 Sant Just Desvern
(Barcelona)
Tel. +34 93 480 33 22
<http://home.frigicoll.es/>
<http://www.kaysun.es/>

MADRID
Senda Galiana, 1
Poligono Industrial Coslada
Coslada (Madrid)
Tel. +34 91 669 97 01
Fax. +34 91 674 21 00
madrid@frigicoll.es